

The AmeriGlide Titan Inclined Platform Lift Installation Guide

AmeriGlide

 **Titan**



Position track mounting legs on steps. The number of legs and spacing will be determined by the overall length and number of pieces of track. If your lift was ordered with the track pre-cut to length, a drawing for your specific installation will detail the leg locations.

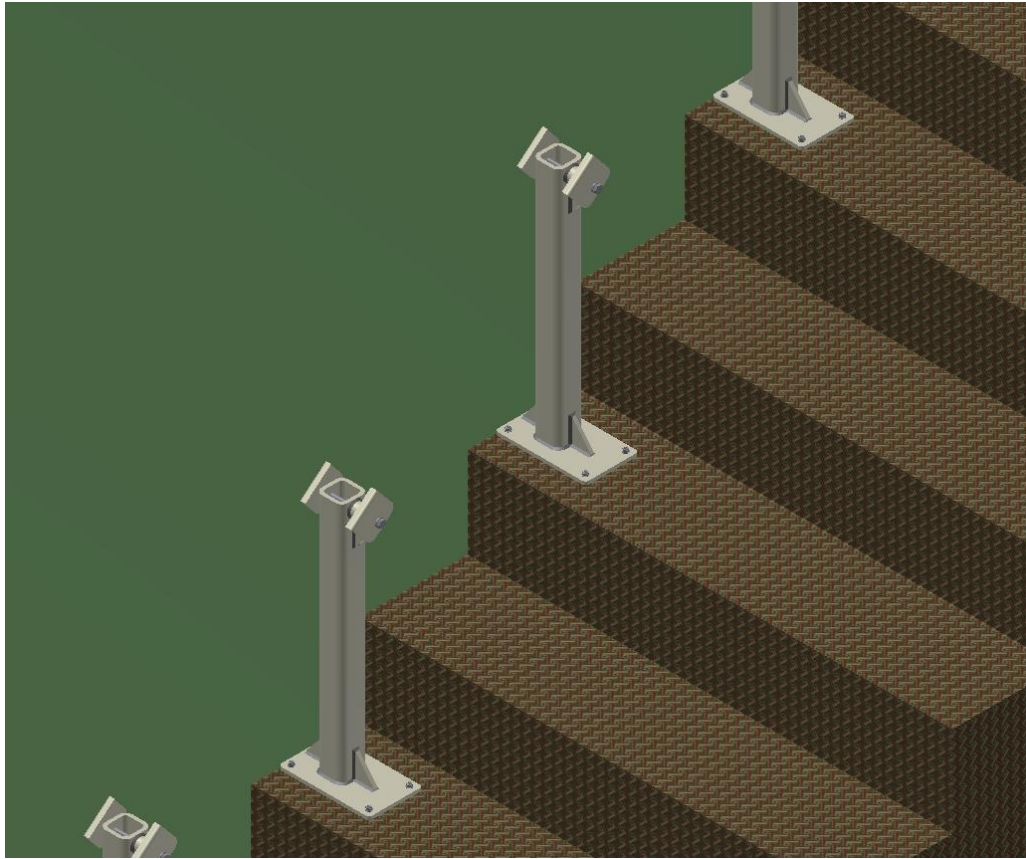

Set the lower section of track into the mounting legs. The clamps fit into a small channel on the bottom of the track. Do not fully tighten the clamps at this time.

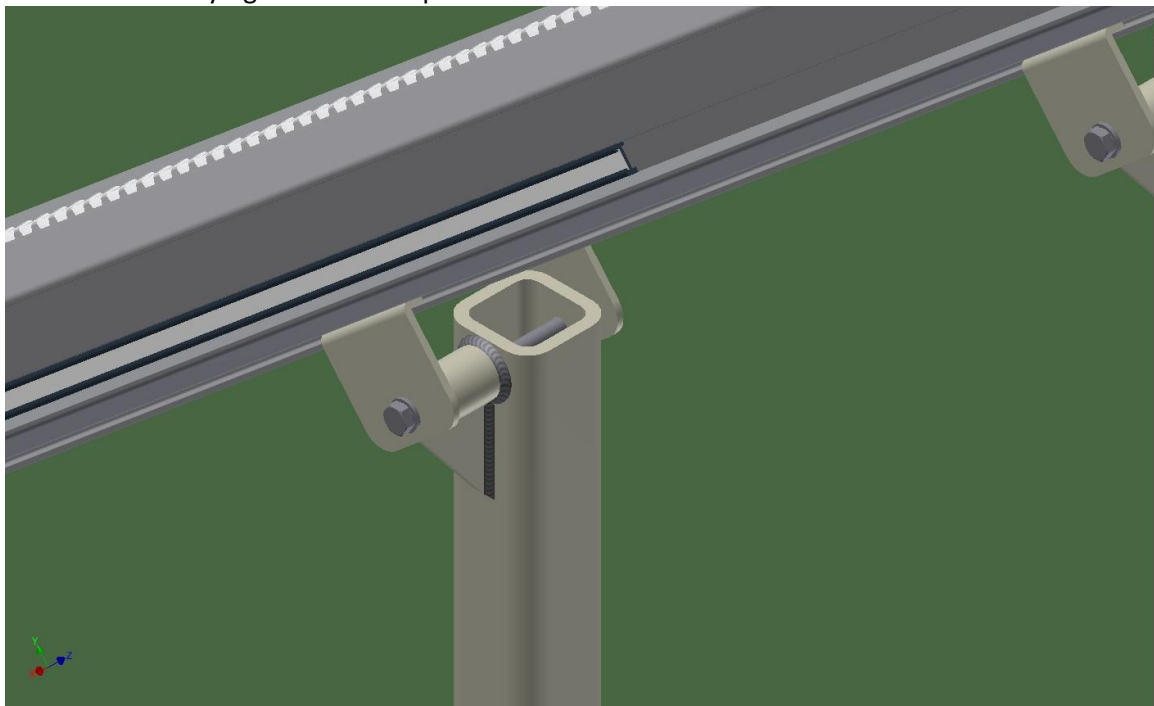

If your lift has multiple track sections, splice them together using the supplied splice bars and screws. The alignment pins will come pre-installed in one of the track sections. Before sliding track sections together be sure to plug together the charge wires running inside the track. After tightening the splice bar screws slide down the sections of gear rack so there are no gaps.

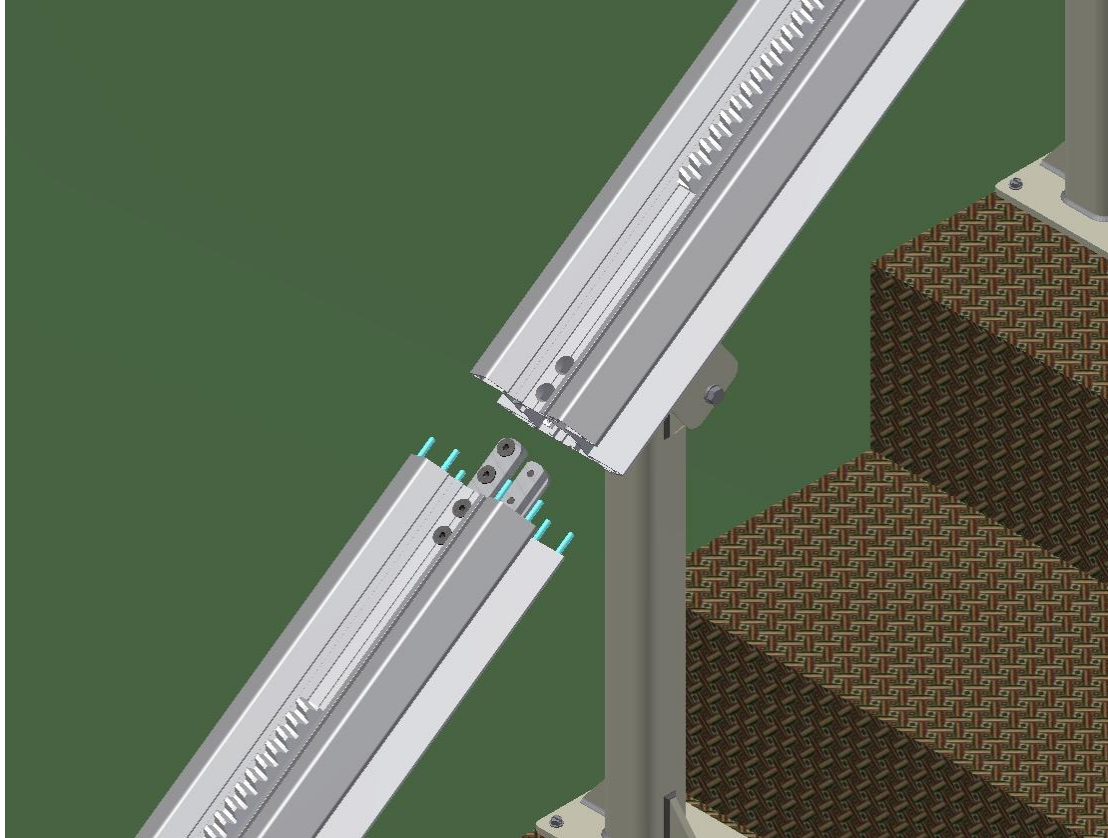

Position the track and mounting legs on the stairs until the desired dimension is obtained from the nose of the steps to the underside of the track. This dimension is noted on your specific installation drawing. The bottom end of the track should be no more than $\frac{1}{2}$ " off the floor and there is a short leg to secure the bottom. After ensuring the track is in the proper location, anchor down the legs with the four #14 wood lags provided with each leg.

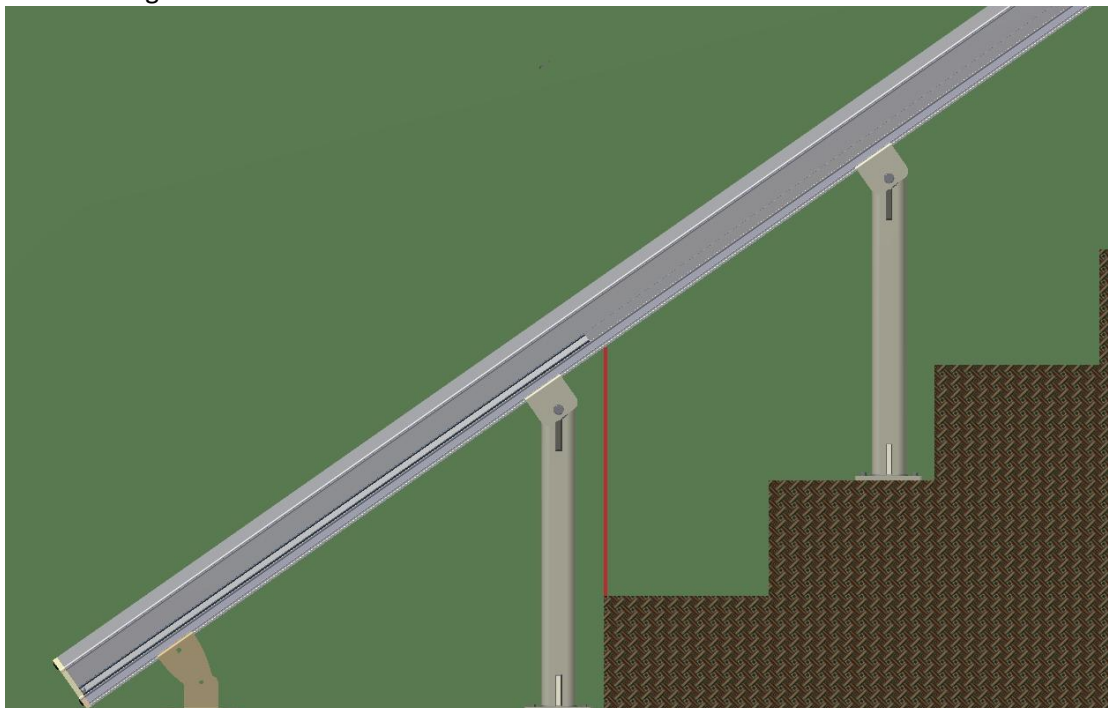

The top end of the track will typically stop short of the top landing and never needs to extend beyond.

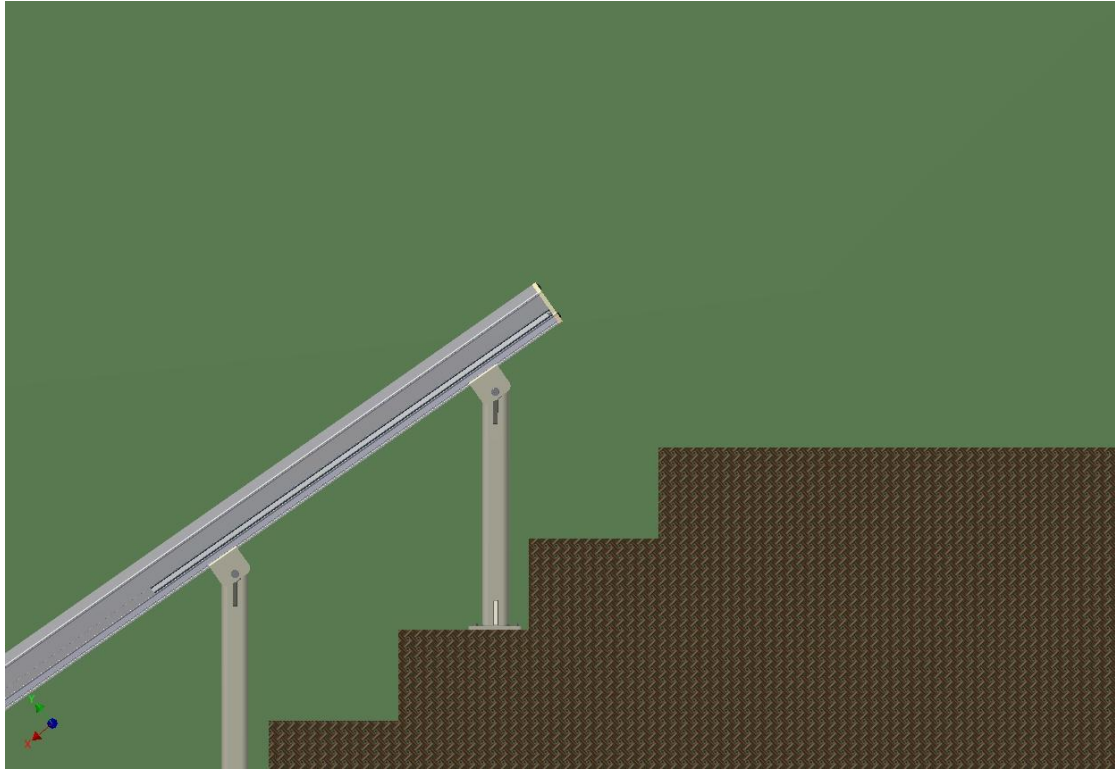

To mark the location for the upper guide rail measure from the leg base plate up the wall 36.25" (as indicated by the red vertical line). Make sure that you make this measurement in the center of the leg and that your measurement is plumb vertically. A 3 or 4 foot level will help ensure this.

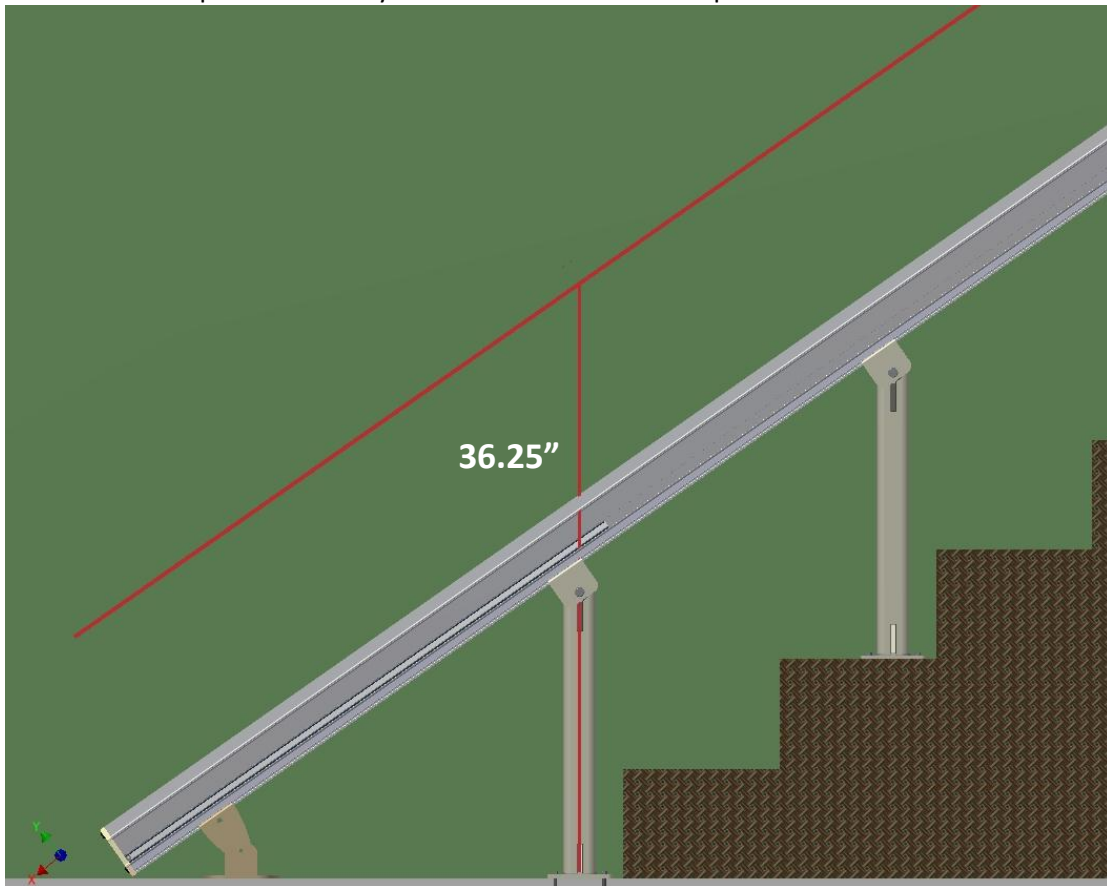

Repeat this measurement at one more leg at a minimum. Then mark a straight line between these measurements. If needed, a chalk line can be filled with talcum powder so there is no risk of discoloring the wall with standard chalk or pencil line.

This line is where the upper guide rail mounting brackets will be anchored.

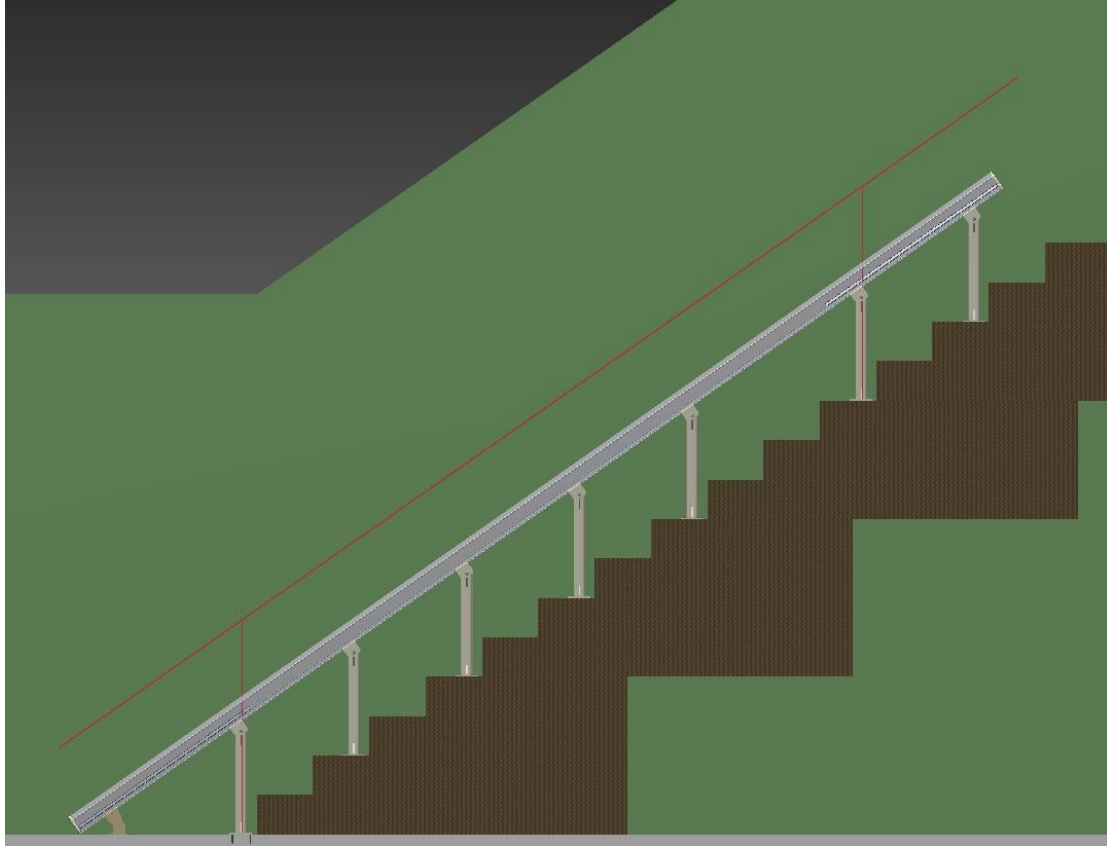

The location of the upper guide rail brackets do not need to be directly above the track mounting legs. They need to be lagged into a wall stud and spaced out evenly. Put one as close to each end of the rail as possible. The guide rail will be longer than needed to allow placing the joint splice directly on one of the mounting brackets. The joint will have one alignment pin and a splice bar. The bracket attachment bolt will tighten into the splice bar and the remaining three set screws are tightened into the splice bar.

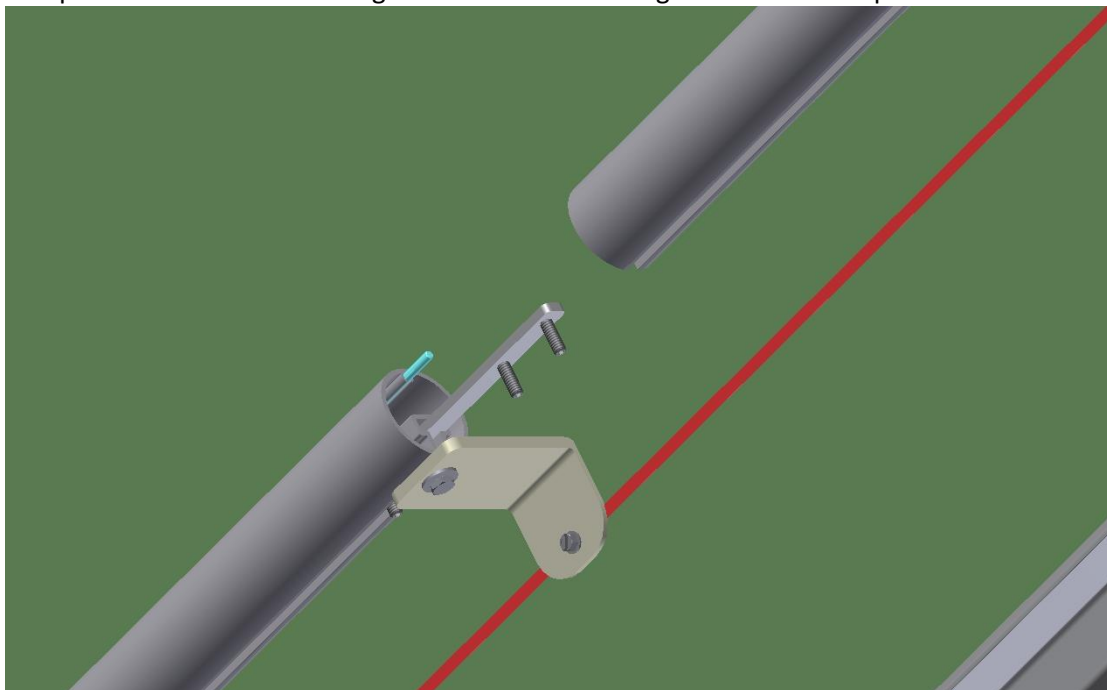

Secure the remaining guide rail mounting brackets to the rail with the threaded bars inside the rail channel. The bottom end of the guide rail should extend at least as far as the bottom end of the track. The upper end may be extended further so the guide rail can be utilized as a handrail for people traversing the stairs on foot.

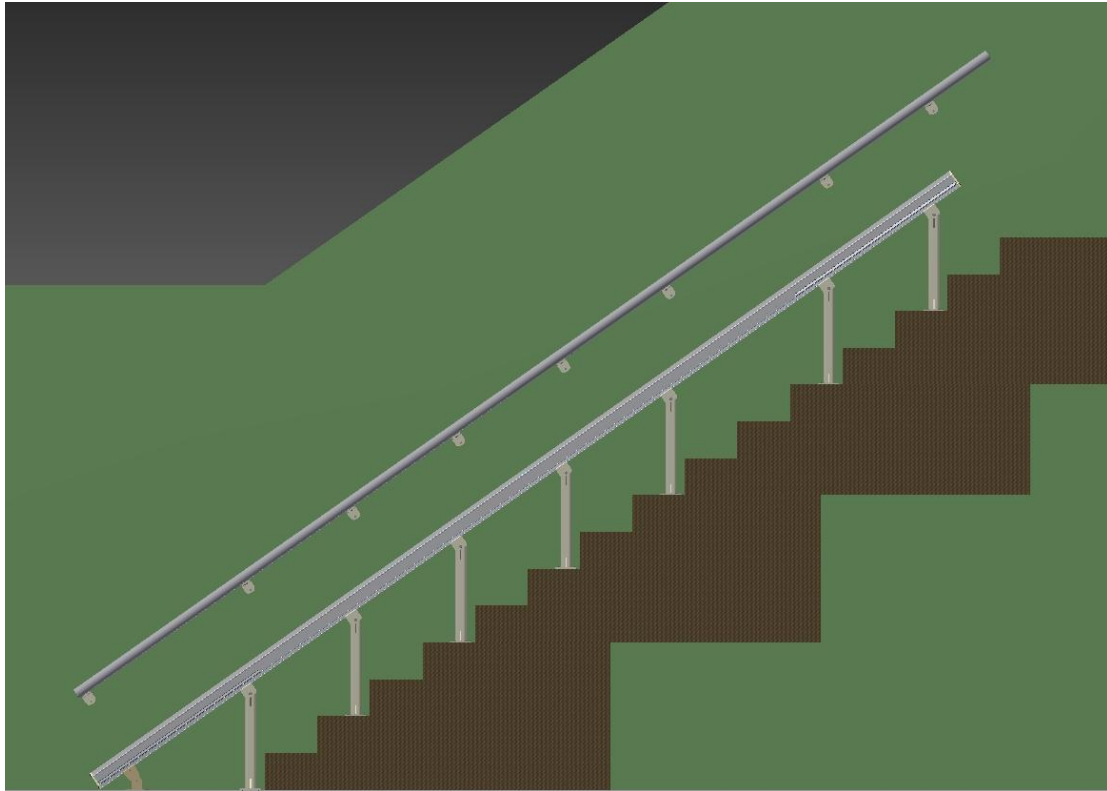

Slide the chassis onto the top of the track until it engages the gear rack. Turn the main power breaker on and the lift will emit a long beep. Run the lift down near the bottom of the track using the install switch (black rocker) on top of the chassis. When you have the lift in the location you want it turn off the main power breaker.

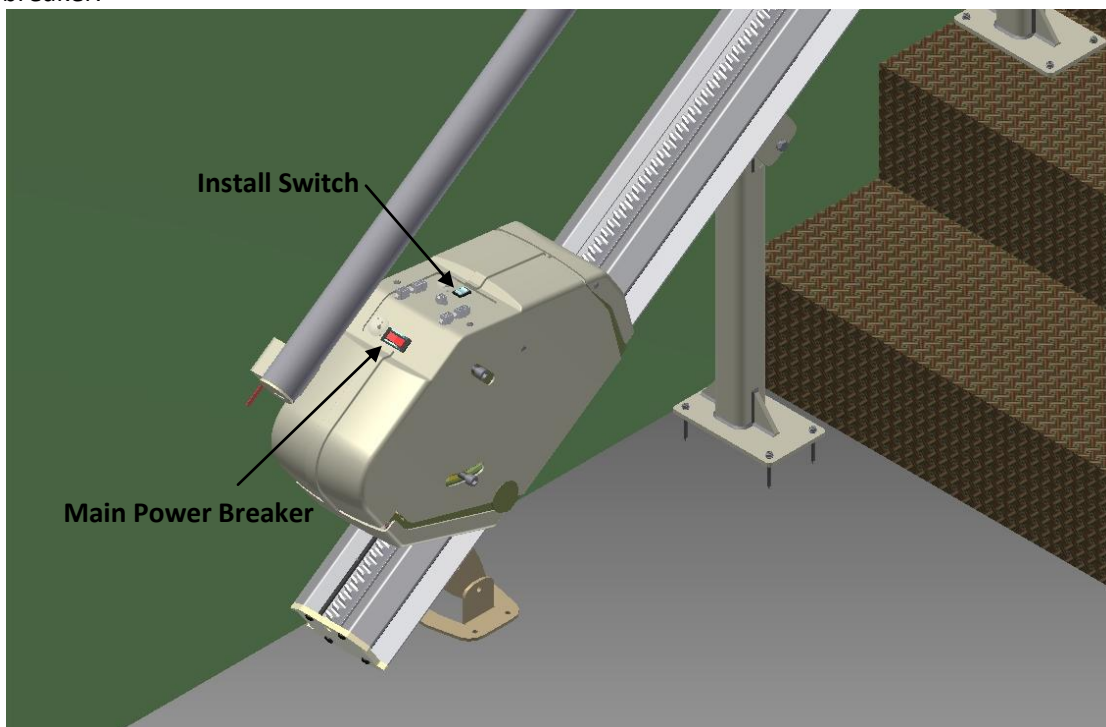

Install the platform mount onto the chassis by aligning the two large holes on the end of the slots with the two large allen headed cap bolts protruding from the side of the chassis. For the bottom slot, use the one on the downhill side of the mount. Ensure that the bolt heads are fully seated in the top of the slots, level the mount and tighten securely. There are two more cap bolts on the back side of the chassis that must be tightened as well.

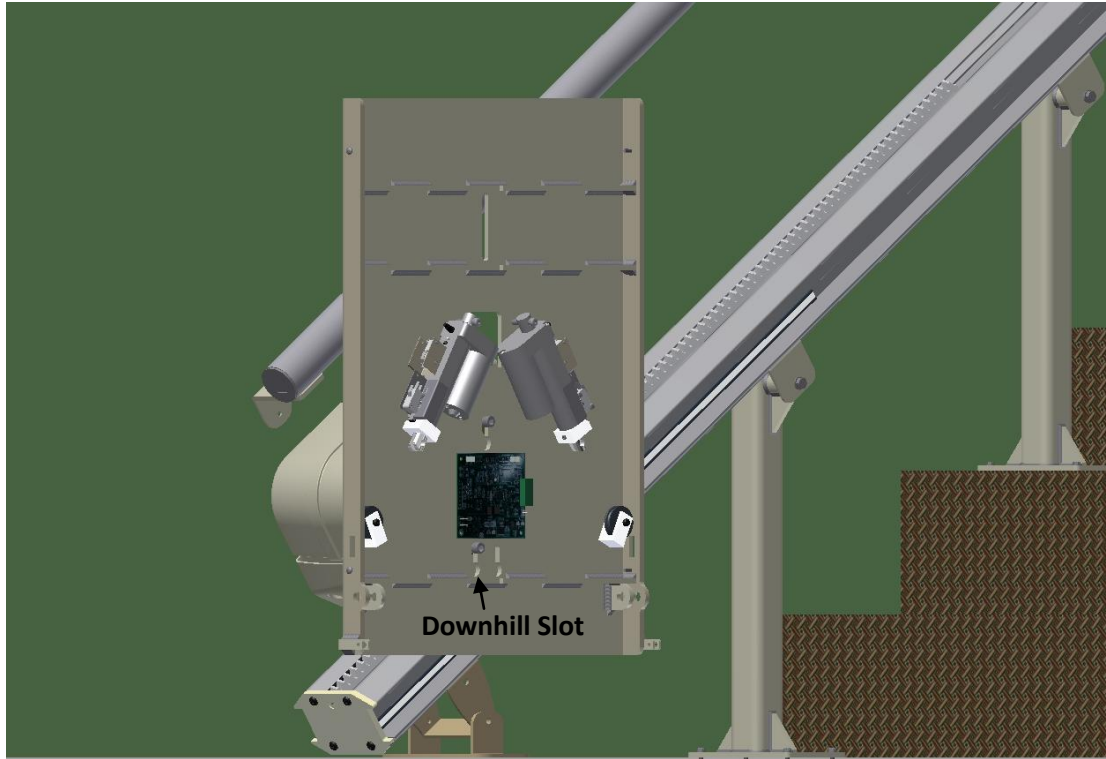

Install the Upper Guide Roller on the back side of the platform mount. Align the two wheels with the guide rail and secure with a washered bolt through the vertical slot in the platform mount. Plug in the three wire harnesses from the platform mount to the top of the chassis. All three plugs are different so they cannot be plugged into the wrong connector.

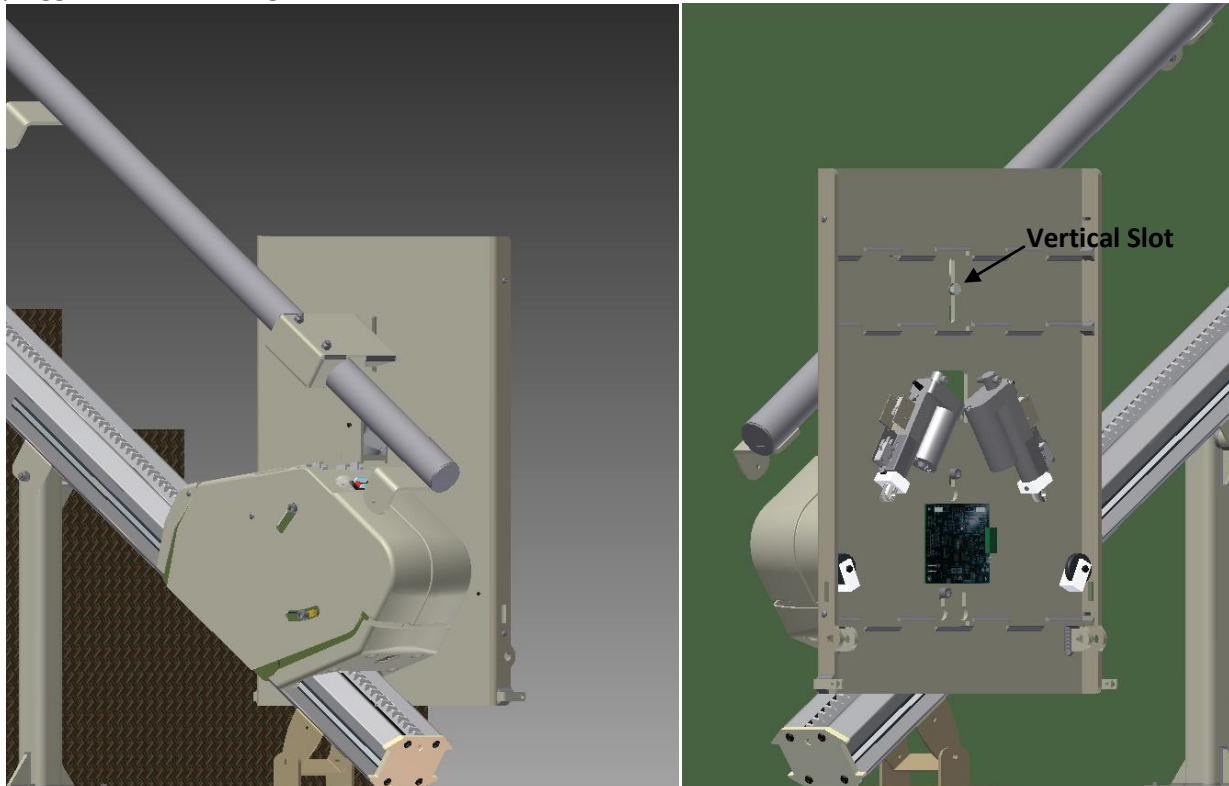

Mount the Platform onto the lift using the shoulder bolts and nuts. Plug in the safety pan wire harness from the platform to the two pin plug on the bottom of the platform mount.

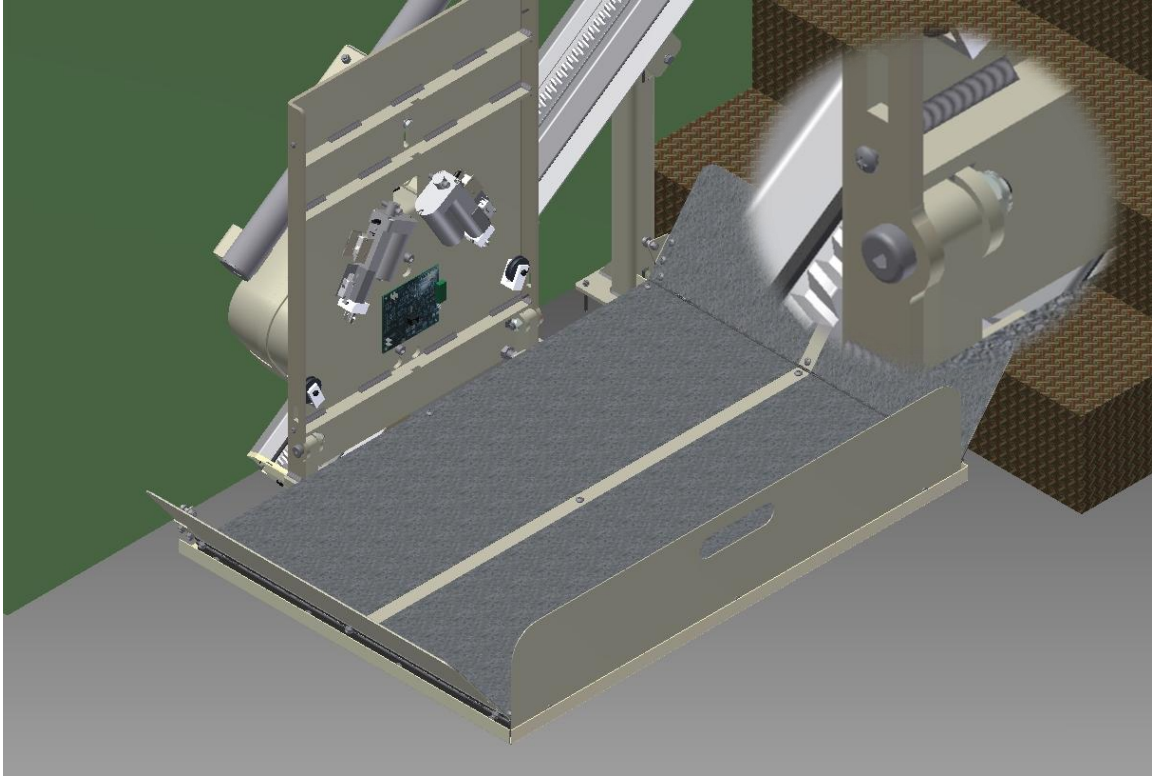

Fold the platform up and attach the ends of the assist struts using the clevis and cotter pins.

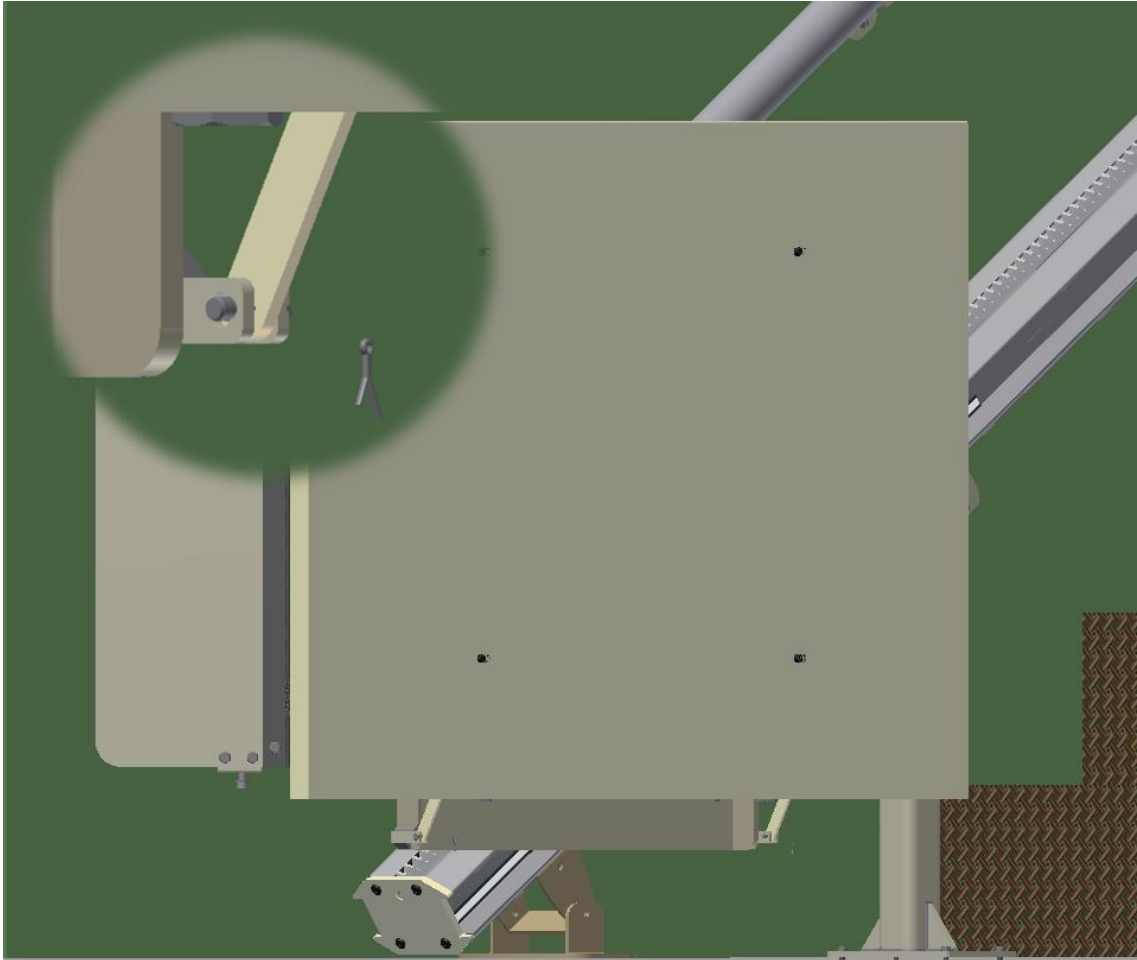

On the back side of the platform are two leveling bolts. Loosen the jam nut on each and turn the bolts in or out to position the platform. When empty the edge furthest away from the chassis should be slightly (1/2" – 3/4") higher to compensate for the deflection when fully loaded with a passenger and chair.

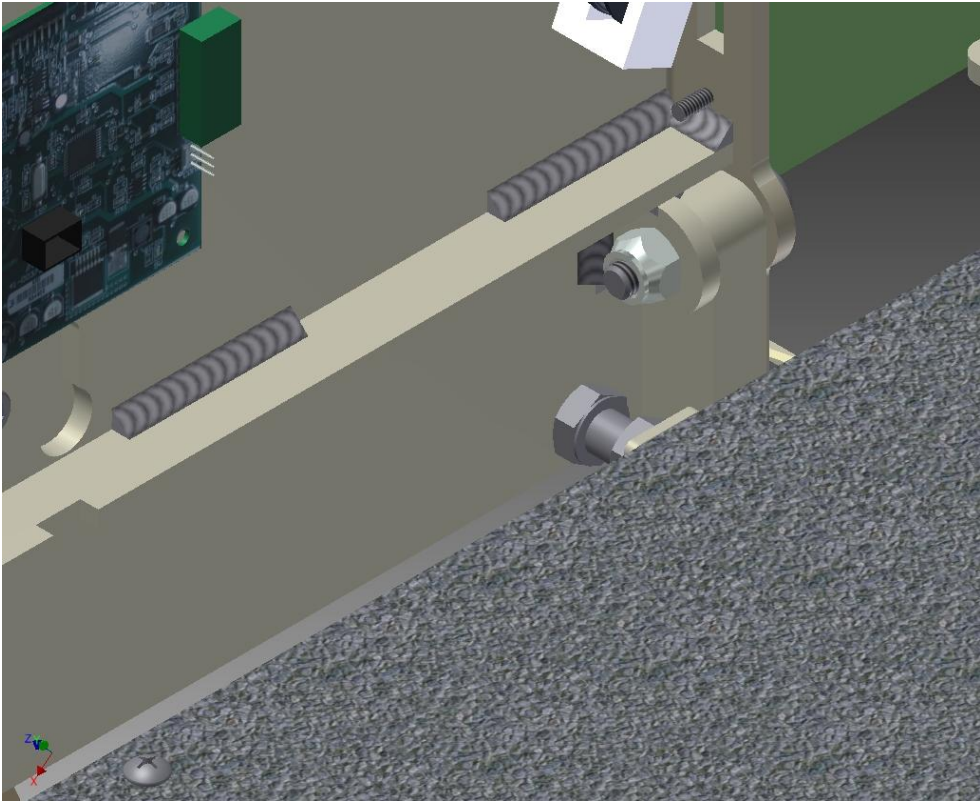

On the ramp control board there are two sets of terminals for the ramp motors, Up and DN. The Up terminals are for the uphill ramp and the DN terminals are for the downhill ramp. Depending on the hand of your lift, it may be necessary to switch the ramp motor wires on these terminals.

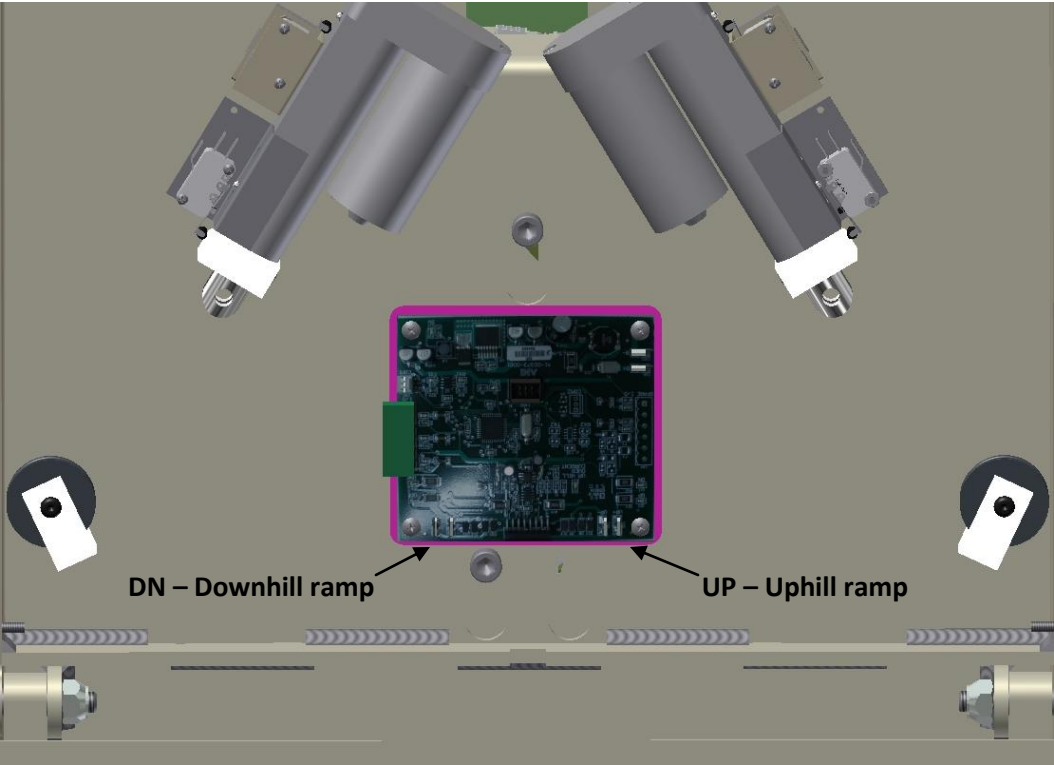

Plug in the harness on the shroud to the harness at the top of the platform mount. Route the two ramp cables through the two slots on either side of the shroud then secure the shroud with the four screws on the sides.

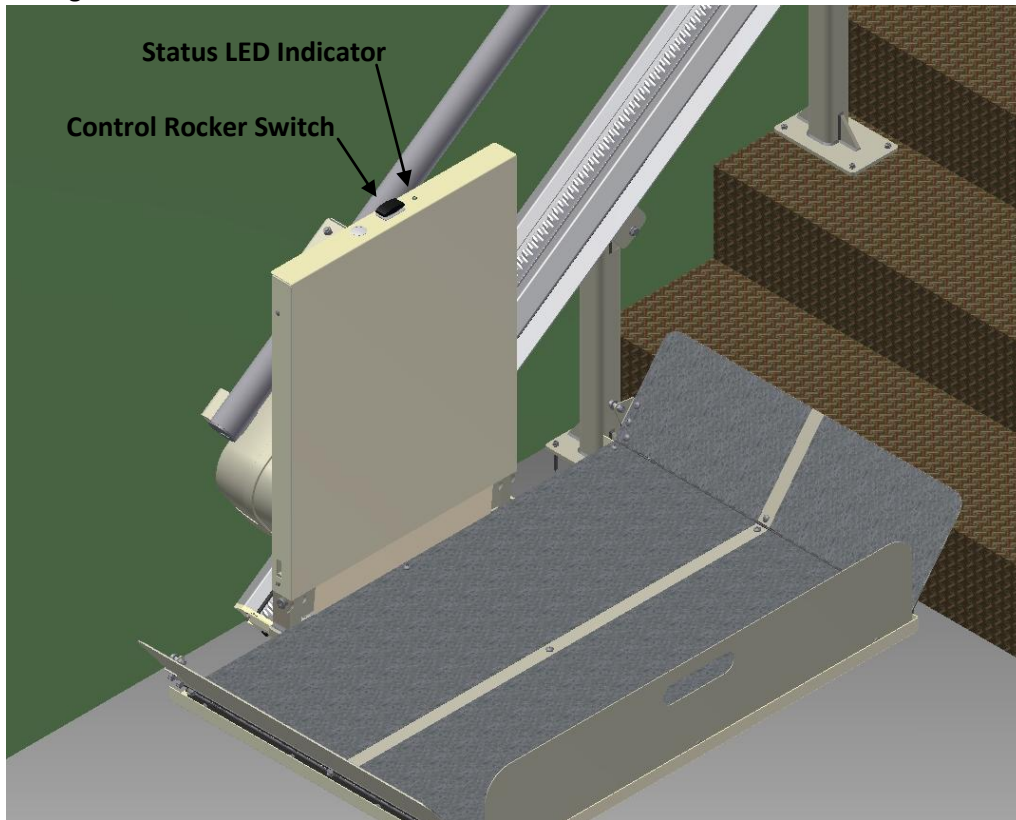

Attach the ends of the ramp cables to each ramp by inserting the shoulder bolts through the loop on the end of the cable.

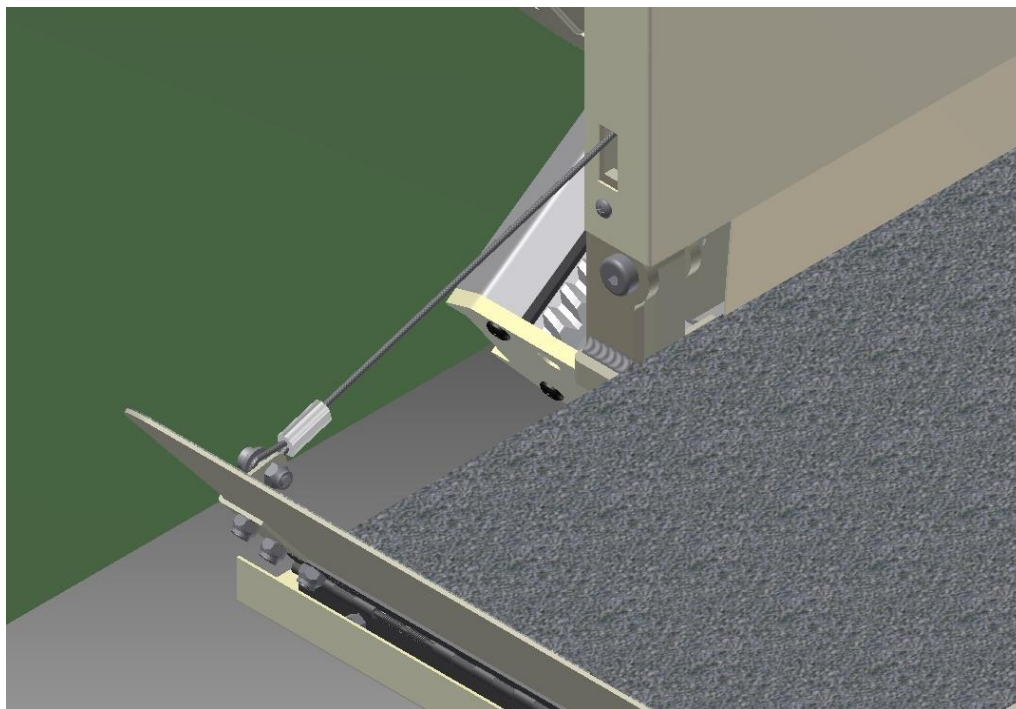

Insert the upper limit cam into the slot in the track at the top and tighten the set screw, this will need to be adjusted later to stop the lift in the proper location. Insert the rest of the gear rack into the top of the track. The gear rack should be even with the end of the track and the last piece may need to be cut off. Install the end plate using the four Torx head screws and Torx driver provided.

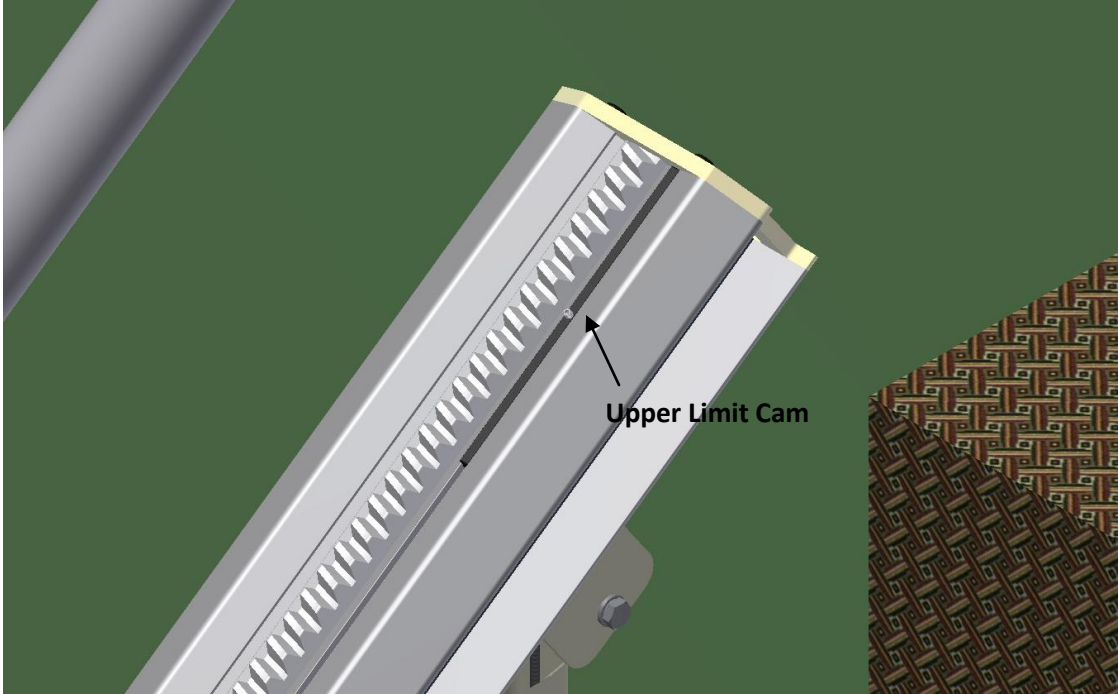

Install the rack compression screw into the end plate to pre-load the gear rack. Install the Hand Rail end plates into each end of the Hand Rail.

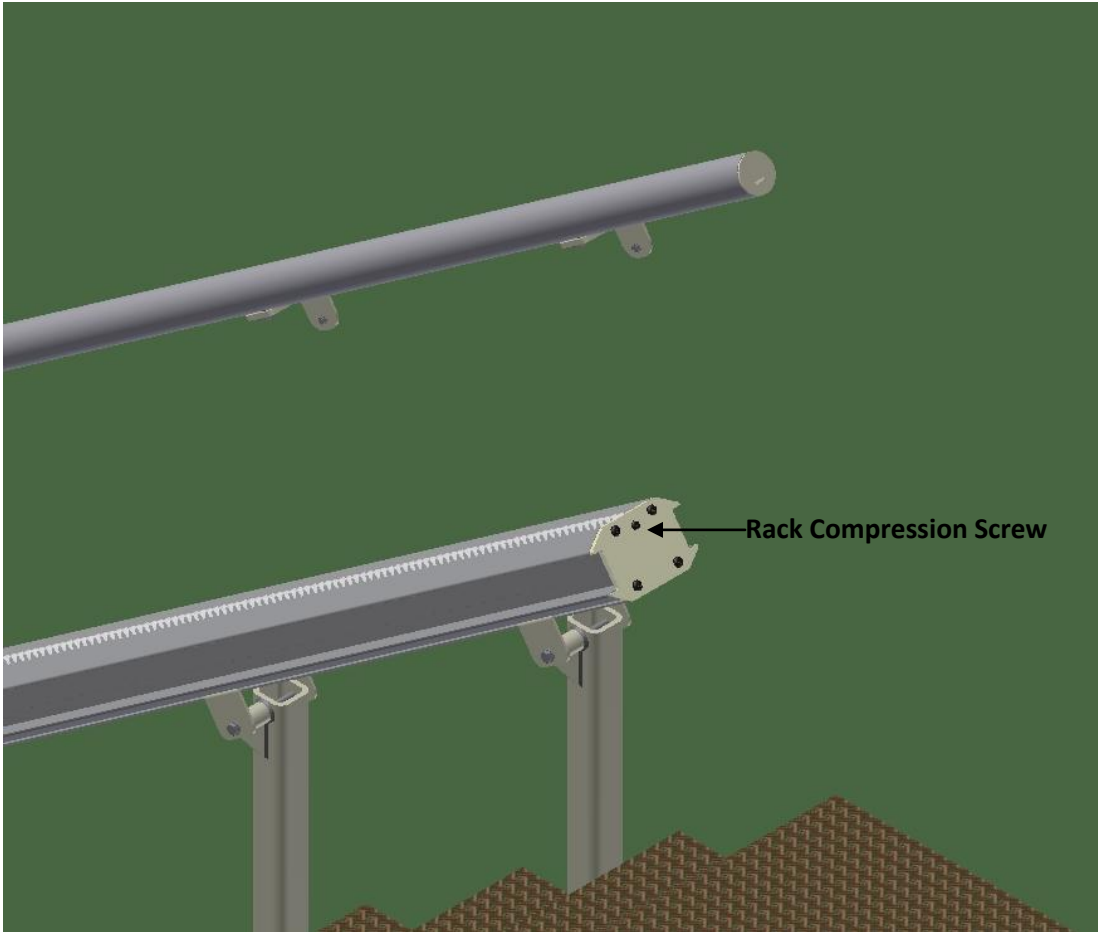

Turn on the main power breaker on the chassis. The status LED indicator will cycle from red to amber to green to off and the lift will emit a beep. The indicator should then return to green and the lift is now ready to run. If the indicator does not return to green check the following.

Amber: indicates an obstruction is triggered. There are five obstruction sensors; uphill chassis, downhill chassis, uphill ramp, downhill ramp, and platform safety pan. Check all of these to ensure that one of these is not triggered and check all wiring connections to these.

Red: indicates a fault or double obstruction. If two or more obstruction sensors are triggered at the same time the lift will disable itself. Turn the main power breaker off, wait a couple of seconds and then turn the breaker back on. If the lift is on the final limit it is also treated as a fault and the lift will have to be hand cranked off the limit.

Run the lift up to the top landing until the lift stops. When the lift comes to a stop, the ramp motor will turn on to lower the ramp. If you let go of the rocker switch the ramp will stop, continue holding the rocker until the ramp stops on its own. It may be necessary to slide the upper limit cam down to get the lift to stop at the proper place in relation to the landing.

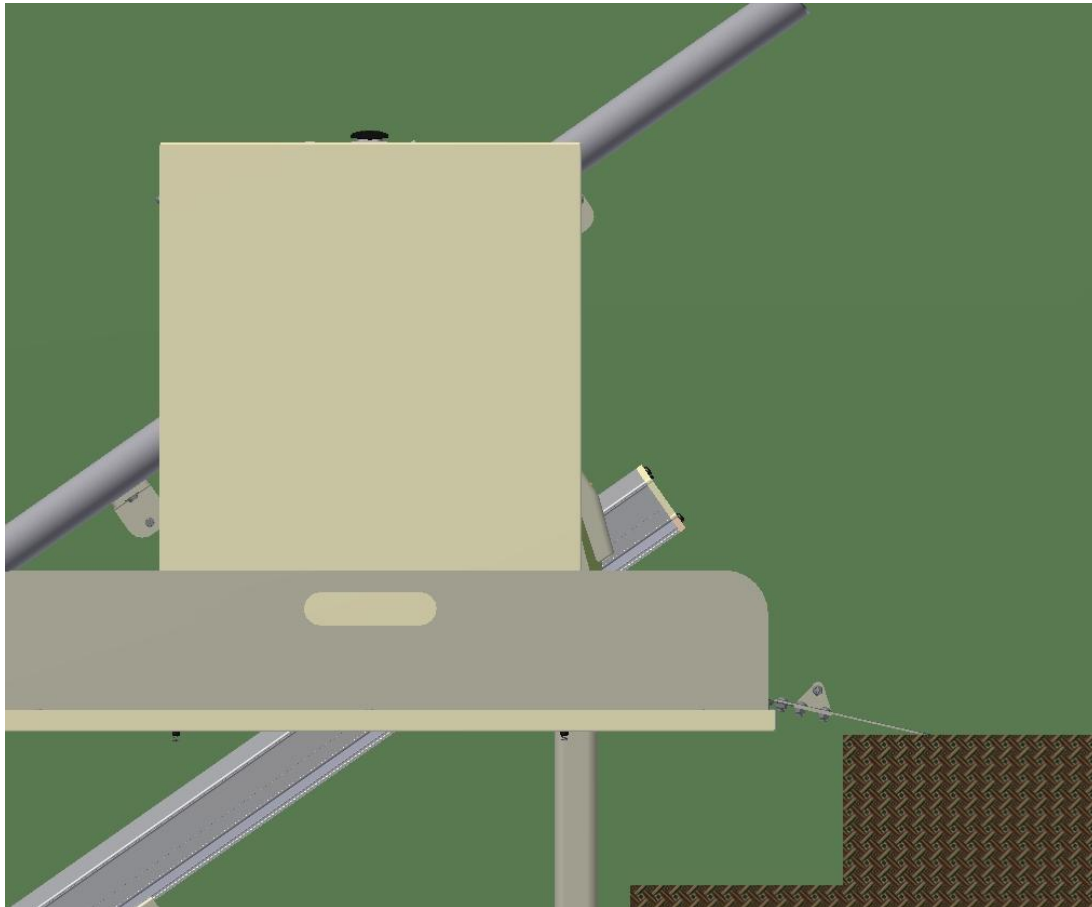

At the top and bottom of the track there is a short wire and plug coming from the end of the track. Plug the charger into one of these plugs and plug the other end of the charger into a wall outlet. You may use whichever end is a more convenient location to a wall outlet.